

Za tehnično podporo ali pomoč pokličite  
**090-6009**



## Zebra LS2208 Quick Start Guide

Več informacij: <http://www.info-kod.si>

---

Vprašanja? Kontaktirajte naše strokovnjake



090-6009



servis@info-kod.si



<http://www.info-kod.si>

Ponedeljek – Petek od 9:00 do 15:00

# LS2208

## QUICK START GUIDE

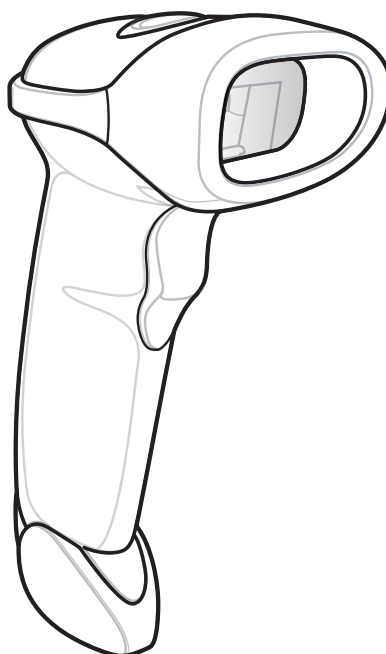

Zebra reserves the right to make changes to any product to improve reliability, function, or design.

Zebra does not assume any product liability arising out of, or in connection with, the application or use of any product, circuit, or application described herein. No license is granted, either expressly or by implication, estoppel, or otherwise under any patent right or patent, covering or relating to any combination, system, apparatus, machine, material, method, or process in which Zebra products might be used. An implied license exists only for equipment, circuits, and subsystems contained in Zebra products.

## **Warranty**

For the complete hardware product warranty statement, go to: <http://www.zebra.com/warranty>.

### **For Australia Only**

This warranty is given by Zebra Technologies Asia Pacific Pte. Ltd., 71 Robinson Road, #05-02/03, Singapore 068895, Singapore. Our goods come with guarantees that cannot be excluded under the Australia Consumer Law. You are entitled to a replacement or refund for a major failure and compensation for any other reasonably foreseeable loss or damage. You are also entitled to have the goods repaired or replaced if the goods fail to be of acceptable quality and the failure does not amount to a major failure. Zebra Technologies Corporation Australia's limited warranty above is in addition to any rights and remedies you may have under the Australian Consumer Law. If you have any queries, please call Zebra Technologies Corporation at +65 6858 0722.

You may also visit our website: <http://www.zebra.com> for the most updated warranty terms.

## **Service Information**

If you have a problem using the equipment, contact your facility's technical or systems support. If there is a problem with the equipment, they will contact the Support Center at: <http://www.zebra.com/support>.

For the latest version of this guide go to: <http://www.zebra.com/support>.

---

### Set Defaults Bar Code



Set Factory Defaults

---

### Scanner Features

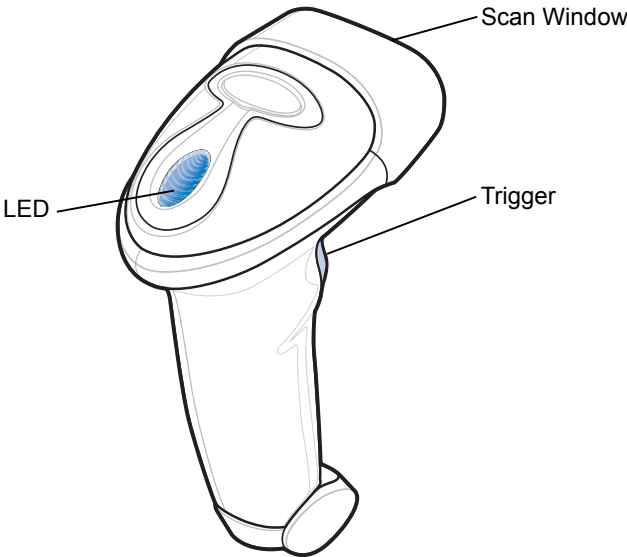

---

### Presentation Mode

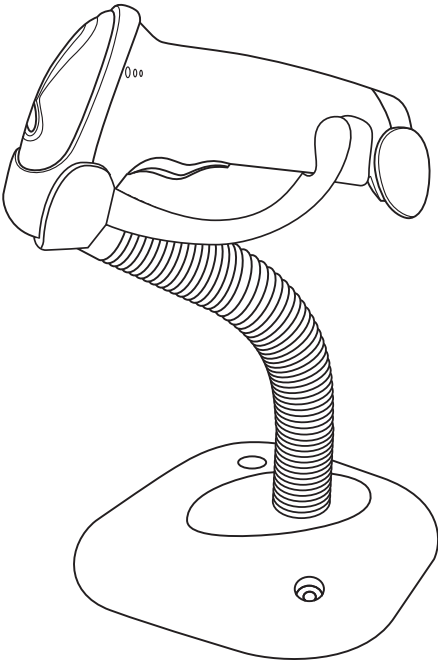

---

## Connect Host Interface

### USB

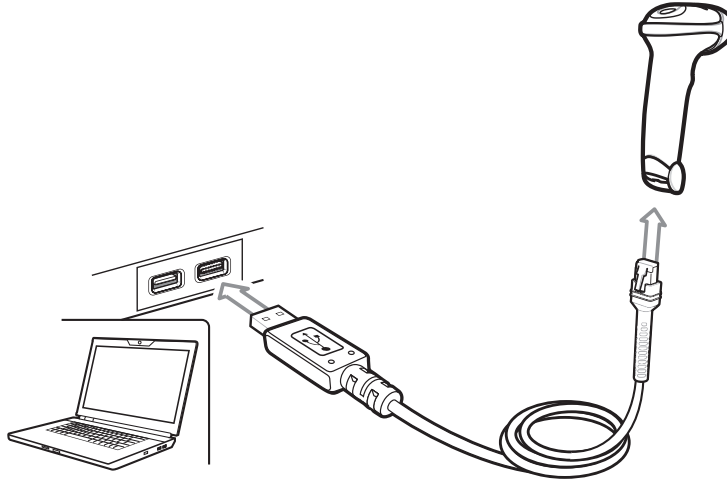

The scanner automatically detects the USB host and uses the default setting. If the default (\*) does not meet your requirements, scan another host bar code below.

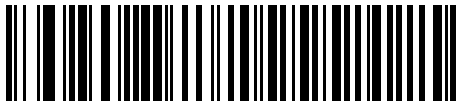

**\*USB Keyboard HID**



**IBM Table-Top USB**

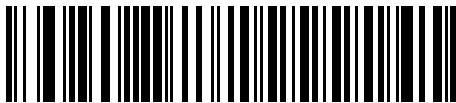

**IBM Hand-Held USB**



**IBM OPOS**  
(IBM Hand-Held USB with Full Scan Disable)



**Symbol Native API (SNAPI) without Imaging Interface**

**RS-232**

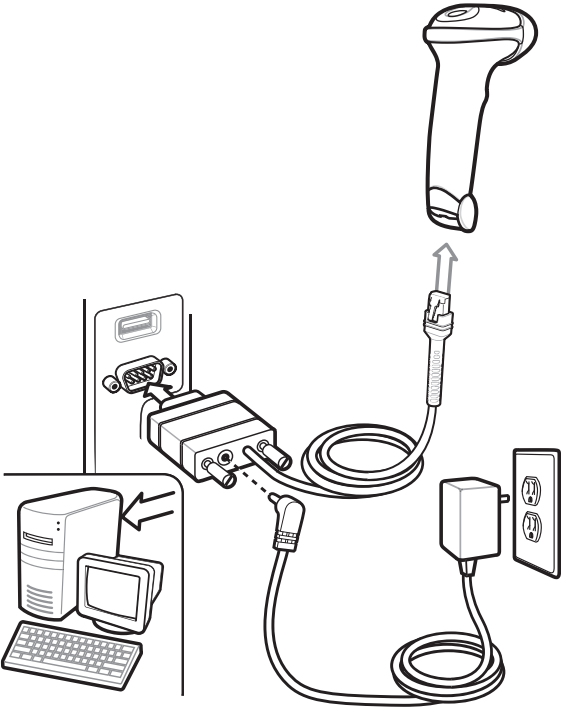

The scanner automatically detects the RS-232 host and uses the default setting. If the default (\*) does not meet your requirements, scan another host bar code below.

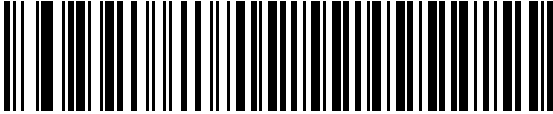

**\*Standard RS-232**

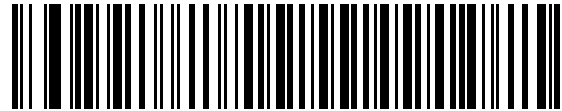

**ICL RS-232**



**Wincor-Nixdorf RS-232 Mode A**



**Wincor-Nixdorf RS-232 Mode B**

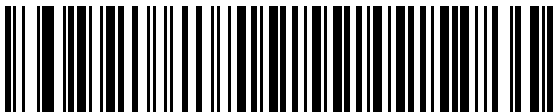

**OPOS/JPOS**



**Fujitsu RS-232**

## Keyboard Wedge

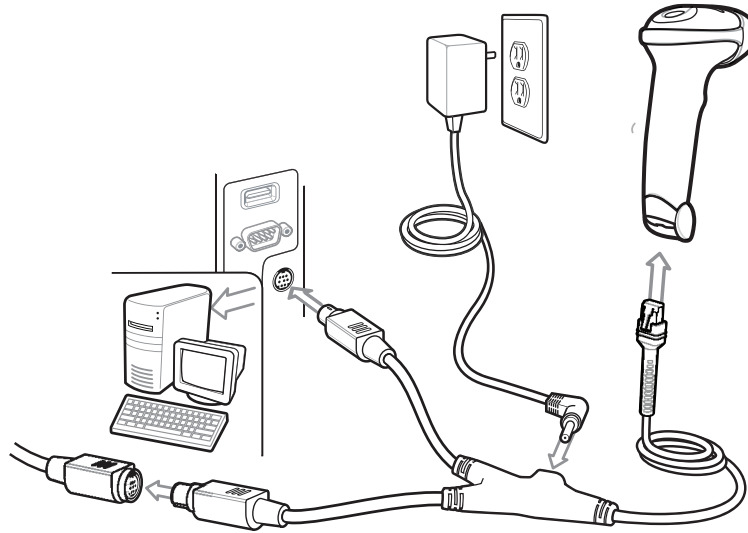

Scanners using an auto-host detect cable automatically detect the keyboard wedge host and use the default setting. If the default (\*) does not meet your requirements, scan the IBM AT NOTEBOOK bar code below.

If using a standard keyboard wedge cable, scan one of the bar codes below.



\*IBM PC/AT & IBM PC Compatible

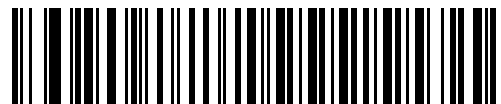

IBM AT Notebook

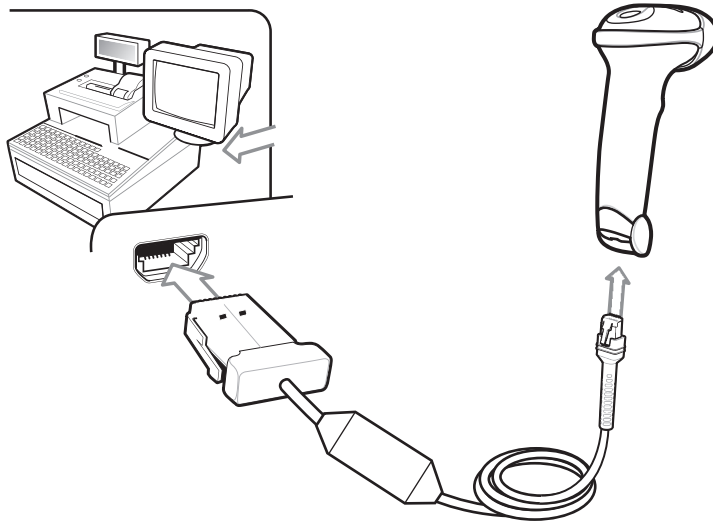

**IBM 46XX**

The scanner automatically detects the IBM host, but there is no default setting. Scan one of the bar codes below to select the appropriate port.

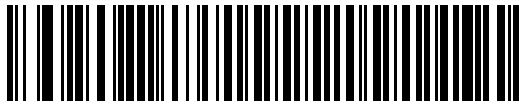

**Non-IBM Scanner Emulation (Port 5B)**

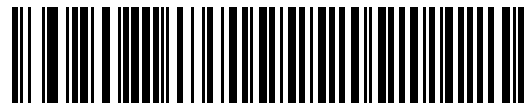

**Hand-Held Scanner Emulation (Port 9B)**

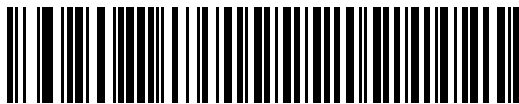
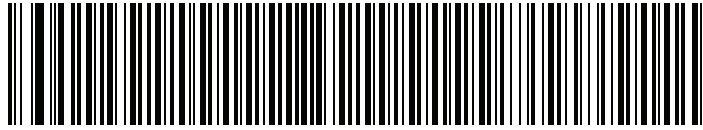

**Table-Top Scanner Emulation (Port 17)**

---

## Enter Key Bar Code (Carriage Return/Line Feed)

Add an Enter key after scanned data.



Enter Key (Carriage Return/Line Feed)

---

## Tab Key Bar Code

Add a Tab key after scanned data.

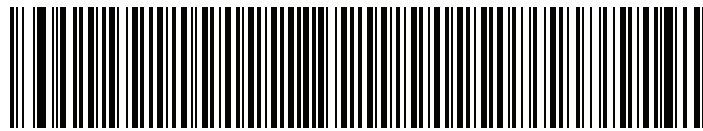

Tab Key

---

## USB Caps Lock Override



Override Caps Lock Key (Enable)



\*Do Not Override Caps Lock Key (Disable)

---

## Scanning



---

## LED Indications

Indication	LED
The scanner is on and ready to scan, or no power to the scanner	Off
A bar code is successfully decoded	Green
Transmission error	Red

---

## Beeper Indications

Indication	Beeper Sequence
Power up	Low/medium/high beep
A bar code is successfully decoded	Short high beep
Transmission error	4 long low beeps
Successful parameter setting	High/low/high/low beep
Correct programming sequence performed	High/low beep
Incorrect programming sequence, or Cancel bar code scanned	Low/high beep

---

## 123Scan<sup>2</sup>

123Scan<sup>2</sup> is an easy-to-use, PC-based software tool that enables rapid and easy customized setup of a scanner via a bar code or USB cable.

For more information, visit: <http://www.zebra.com/123Scan2>.

### Utility Functionality

- Device configuration
  - Electronic programming (USB cable)
  - Programming bar code(s)
- Data view – Scan log (display scanned bar code data)
- Access asset tracking information
- Upgrade firmware and view release notes

---

## Recommended Usage / Optimum Body Posture

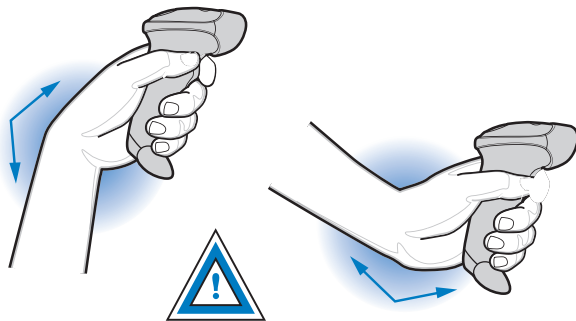

**Avoid Extreme Wrist Angles**

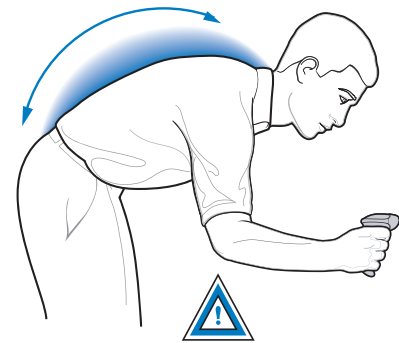

**Avoid Bending**

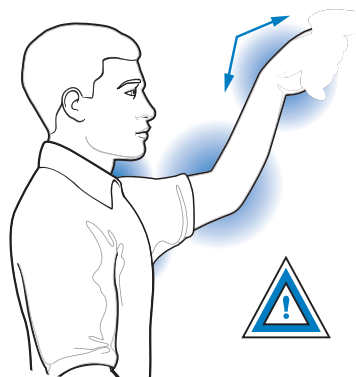

**Avoid Reaching**

## Troubleshooting

Indication	Resolution
<b>Scanner is not working</b>	
No power to scanner	Check system power
Scanner is disabled	Ensure that correct host interface cable is used
<b>Scanner decodes bar code but does not transmit data</b>	
Host interface not configured properly	Use auto-host detect cable, or scan appropriate host bar codes
Interface cable is loose	Ensure all cable connections are secure
<b>Scanner does not decode bar code</b>	
Scanner not programmed for bar code type	Enable that bar code type
Bar code is unreadable	Ensure the bar code is not defaced; scan a test bar code of the same bar code type
Distance between scanner and bar code is incorrect	Move the scanner closer to or further from the bar code
<b>Scanned data incorrectly displayed on host</b>	
Host interface not configured properly	Scan appropriate host parameter bar codes

---

## Regulatory Information

This guide applies to Model Number: LS2208.

All Zebra devices are designed to be compliant with rules and regulations in locations they are sold and will be labeled as required. Local language translations are available at the following website:  
<http://www.zebra.com/support>.

Any changes or modifications to Zebra equipment, not expressly approved by Zebra, could void the user's authority to operate the equipment.

**CAUTION:** Only use Zebra approved and UL Listed accessories.

Declared maximum operating temperature: 40°C.

## Laser Devices



Complies with 21CFR1040.10 & 1040.11 except for deviations pursuant to Laser Notice NO. 50, dated June 24, 2007 and IEC/EN 60825-1:2007 and/or IEC/EN 60825-1:2014.

The following statement is required to comply with US and international regulations:

**Caution: Use of controls, adjustments or performance of procedures other than those specified herein may result in hazardous laser light exposure.**

Class 2 laser scanners use a low power, visible light diode. As with any very bright light source, such as the sun, the user should avoid staring directly into the light beam. Momentary exposure to a Class 2 laser is not known to be harmful.

## Health and Safety Recommendations



### Ergonomic Recommendations

**Caution:** In order to avoid or minimize the potential risk of ergonomic injury follow the recommendations below. Consult with your local Health & Safety Manager to ensure that you are adhering to your company's safety programs to prevent employee injury.

- Reduce or eliminate repetitive motion
- Maintain a natural position
- Reduce or eliminate excessive force
- Keep objects that are used frequently within easy reach
- Perform tasks at correct heights
- Reduce or eliminate vibration
- Reduce or eliminate direct pressure
- Provide adjustable workstations
- Provide adequate clearance
- Provide a suitable working environment
- Improve work procedures.

## Power Supply

Use ONLY a Zebra approved UL LISTED ITE (IEC/EN 60950-1, SELV) power supply with electrical ratings: Output 5Vdc, min 650mA, with a maximum ambient temperature of at least 40 degrees C. Use of alternative power supply will invalidate any approvals given to this unit and may be dangerous.

## Radio Frequency Interference Requirements - FCC



Note: This equipment has been tested and found to comply with the limits for a Class B digital device, pursuant to Part 15 of the FCC rules. These limits are designed to provide reasonable protection against harmful interference in a residential installation.

This equipment generates, uses and can radiate radio frequency energy and, if not installed and used in accordance with the instructions, may cause harmful interference to radio communications. However there is no guarantee that interference will not occur in a particular installation. If this equipment does cause harmful interference to radio or television reception, which can be determined by turning the equipment off and on, the user is encouraged to try to correct the interference by one or more of the following measures:

- Reorient or relocate the receiving antenna
- Increase the separation between the equipment and receiver
- Connect the equipment into an outlet on a circuit different from that to which the receiver is connected
- Consult the dealer or an experienced radio/TV technician for help.

## Radio Frequency Interference Requirements - Canada

This Class B digital apparatus complies with Canadian ICES-003.

Cet appareil numérique de la classe B est conforme à la norme NMB-003 du Canada.



## Statement of Compliance

Zebra hereby declares that this device is in compliance with all applicable Directives, 2014/30/EU, 2014/35/EU and 2011/65/EU. The full text of the EU Declaration of Conformity is available at the following internet address: <http://www.zebra.com/doc>.

## Japan (VCCI) - Voluntary Control Council for Interference

### Class B ITE

この装置は、クラスB情報技術装置です。この装置は、家庭環境で使用することを目的としていますが、この装置がラジオやテレビジョン受信機に近接して使用されると、受信障害を引き起こすことがあります。  
取扱説明書に従って正しい取り扱いをして下さい。 VCCI-B

## Korea Warning Statement for Class B ITE

<p>기종 별 B급 기기 (가정용 방송통신기자재)</p>	<p>사용자 안내문 이 기기는 가정용(B급) 전자파적합기기로서 주로 가정에서 사용하는 것을 목적으로 하며, 모든 지역에서 사용할 수 있습니다.</p>
---	---

## Other Countries

### Brazil

Regulatory declarations for LS2208 - BRAZIL

For more information consult the website [www.anatel.gov.br](http://www.anatel.gov.br)

Declarações Regulamentares para LS2208 - Brazil

Nota: A marca de certificação se aplica ao Transceptor, modelo LS2208. Este equipamento opera em caráter secundário, isto é, não tem direito a proteção contra interferência prejudicial, mesmo de estações do mesmo tipo, e não pode causar interferência a sistemas operando em caráter primário.

Para maiores informações sobre ANATEL consulte o site: [www.anatel.gov.br](http://www.anatel.gov.br)

### Chile

Este equipo cumple con la Resolución No 403 de 2008, de la Subsecretaria de telecomunicaciones, relativa a radiaciones electromagnéticas.

### Mexico

Restrict Frequency Range to: 2.450 – 2.4835 GHz.

La operación de este equipo está sujeta a las siguientes dos condiciones: (1) es posible que este equipo o dispositivo no cause interferencia perjudicial y (2) este equipo o dispositivo debe aceptar cualquier interferencia, incluyendo la que pueda causar su operación no deseada.

### S. Korea

For a radio equipment using 2400~2483.5MHz or 5725~5825MHz, the following two expression should be displayed;

무선설비는 운용 중 전파혼신 가능성이 있음  
당해 무선설비는 전파혼신 가능성이 있으므로 인명안전과 관련된 서비스는 할 수 없습니다.



## Taiwan

### 臺灣

#### 低功率電波輻射性電機管理辦法

#### 第十二條

經型式認證合格之低功率射頻電機，非經許可，公司、商號或使用者均不得擅自變更頻率、加大功率或變更原設計之特性及功能。

#### 第十四條

低功率射頻電機之使用不得影響飛航安全及干擾合法通信；經發現有干擾現象時，應立即停用，並改善至無干擾時方得繼續使用。前項合法通信，指依電信規定作業之無線電通信。低功率射頻電機須忍受合法通信或工業、科學及醫療用電波輻射性電機設備之干擾。

## Ukraine

Дане обладнання відповідає вимогам технічного регламенту №1057, № 2008 на обмеження щодо використання деяких небезпечних речовин в електричних та електронних пристроях.

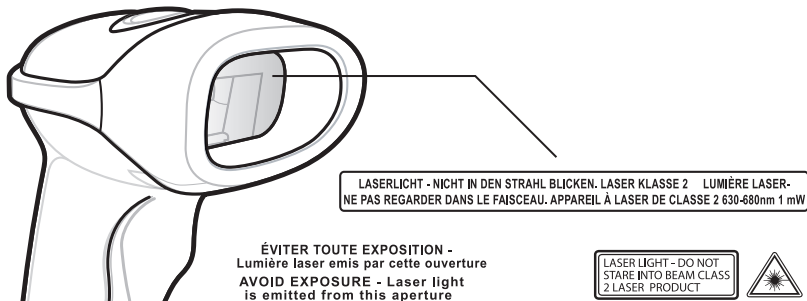



## Waste Electrical and Electronic Equipment (WEEE)

**English:** For EU Customers: All products at the end of their life must be returned to Zebra for recycling. For information on how to return product, please go to: <http://www.zebra.com/weee>.

**Български:** За клиенти от ЕС: След края на полезния им живот всички продукти трябва да се връщат на Zebra за рециклиране. За информация относно връщането на продукти, моля отидете на адрес: <http://www.zebra.com/weee>.

**Čeština:** Pro zákazníky z EU: Všechny produkty je nutné po skončení jejich životnosti vrátit společnosti Zebra k recyklaci. Informace o způsobu vrácení produktu najdete na webových stránkách: <http://www.zebra.com/weee>.

**Dansk:** Til kunder i EU: Alle produkter skal returneres til Zebra til recirkulering, når de er udtjent. Læs oplysningerne om returnering af produkter på: <http://www.zebra.com/weee>.

**Deutsch:** Für Kunden innerhalb der EU: Alle Produkte müssen am Ende ihrer Lebensdauer zum Recycling an Zebra zurückgesandt werden. Informationen zur Rücksendung von Produkten finden Sie unter <http://www.zebra.com/weee>.

**Eesti:** EL klientidele: kõik tooted tuleb nende eluea lõppedes tagastada taaskasutamise eesmärgil Zebra'ile.

Lisainformatsiooni saamiseks toote tagastamise kohta külastage palun aadressi: <http://www.zebra.com/weee>.

**Español:** Para clientes en la Unión Europea: todos los productos deberán entregarse a Zebra al final de su ciclo de vida para que sean reciclados. Si desea más información sobre cómo devolver un producto, visite: <http://www.zebra.com/weee>.

**Ελληνικά :** Για πελάτες στην Ε.Ε.: Όλα τα προϊόντα, στο τέλος της διάρκειας ζωής τους, πρέπει να επιστρεφθούν στην Zebra για ανακύκλωση. Για περισσότερες πληροφορίες σχετικά με την επιστροφή ενός προϊόντος, επισκεφθείτε τη διεύθυνση <http://www.zebra.com/weee> στο Διαδίκτυο.

**Français :** Clients de l'Union Européenne : Tous les produits en fin de cycle de vie doivent être retournés à Zebra pour recyclage. Pour de plus amples informations sur le retour de produits, consultez : <http://www.zebra.com/weee>.

**Italiano:** per i clienti dell'UE: tutti i prodotti che sono giunti al termine del rispettivo ciclo di vita devono essere restituiti a Zebra al fine di consentirne il riciclaggio. Per informazioni sulle modalità di restituzione, visitare il seguente sito Web: <http://www.zebra.com/weee>.

**Lietuvių:** ES vartotojams: visi gaminiai, pasibaigus jų eksploatacijos laikui, turi būti gražinti utilizuoti į kompaniją „Zebra“. Daugiau informacijos, kaip gražinti gaminių, rasite: <http://www.zebra.com/weee>.

**Latviešu:** ES klientiem: visi produkti pēc to kalpošanas mūža beigām ir jānogādā atpakaļ Zebra otrreizējai pārstrādei. Lai iegūtu informāciju par produktu nogādāšanu Zebra, lūdz, skatiet: <http://www.zebra.com/weee>.

**Magyar:** Az EU-ban vásárlóknak: Minden tönkrement termékét a Zebra vállalatához kell eljuttatni újrahasznosítás céljából. A termék visszajuttatásának módjával kapcsolatos tudnivalóért látogasson el a <http://www.zebra.com/weee> weboldalra.

**Malti:** Għal klijenti fl-UE: il-prodotti kollha li jkunu waslu fl-aħħar tal-ħajja ta' l-użu tagħhom, iridu jiġu rritornati għand Zebra għar-riciklaġġ. Għal aktar tagħrif dwar kif għandek tirritorna l-prodott, jekk jogħġbok żur: <http://www.zebra.com/weee>.

**Nederlands:** Voor klanten in de EU: alle producten dienen aan het einde van hun levensduur naar Zebra te worden teruggezonden voor recycling. Raadpleeg <http://www.zebra.com/weee> voor meer informatie over het terugzenden van producten.

**Polski:** Klienci z obszaru Unii Europejskiej: Produkty wycofane z eksploatacji należy zwrócić do firmy Zebra w celu ich utylizacji. Informacje na temat zwrotu produktów znajdują się na stronie internetowej <http://www.zebra.com/weee>.

**Português:** Para clientes da UE: todos os produtos no fim de vida devem ser devolvidos à Zebra para reciclagem. Para obter informações sobre como devolver o produto, visite: <http://www.zebra.com/weee>.

**Românesc:** Pentru clienții din UE: Toate produsele, la sfârșitul duratei lor de funcționare, trebuie returnate la Zebra pentru reciclare. Pentru informații despre returnarea produsului, accesați: <http://www.zebra.com/weee>.

**Slovenski:** Za kupce v EU: vsi izdelki se morajo po poteku življenjske dobe vrniti podjetju Zebra za reciklažo. Za informacije o vračilu izdelka obiščite: <http://www.zebra.com/weee>.

**Suomi:** Asiakkaita Euroopan unionin alueella: Kaikki tuotteet on palautettava kierrätettäväksi Zebra-yhtiöön, kun tuotetta ei enää käytetä. Lisätietoja tuotteiden palauttamisesta on osoitteessa <http://www.zebra.com/weee>.

**Svenska:** För kunder inom EU: Alla produkter som uppnått sin livslängd måste returneras till Zebra för återvinning. Information om hur du returnerar produkten finns på <http://www.zebra.com/weee>.

**Türkçe:** AB Müşterileri için: Kullanım süresi dolan tüm ürünler geri dönüştürme için Zebra'ya iade edilmelidir. Ürünlerin nasıl iade edileceği hakkında bilgi için lütfen şu adresi ziyaret edin: <http://www.zebra.com/weee>.

## TURKISH WEEE Statement of Compliance

EEE Yönetmeligine Uygundur

## CMM Disclosure

This table was created to comply with China RoHS requirements.

部件名称 (Parts)	有害物质					
	铅 (Pb)	汞 (Hg)	镉 (Cd)	六价铬 (Cr(VI))	多溴联苯 (PBB)	多溴二苯 醚 (PBDE)
金属部件 (Metal Parts)	0	0	0	0	0	0
电路模块 (Circuit Modules)	X	0	0	0	0	0
电缆及电缆组件 (Cables and Cable Assemblies)	X	0	0	0	0	0
塑料和聚合物部件 (Plastic and Polymeric Parts)	0	0	0	0	0	0
光学和光学组件 (Optics and Optical Components)	X	0	X	0	0	0
电池 (Batteries)	0	0	0	0	0	0

本表格依据SJ/T 11364 的规定编制。

- 0: 表示该有害物质在该部件所有均质材料中的含量均在 GB/T 26572 规定的限量要求以下。  
 X: 表示该有害物质至少在该部件的某一均质材料中的含量超出 GB/T 26572 规定的限量要求。(企业可在此处, 根据实际情况对上表中打“X”的技术原因进行进一步说明。)





Zebra Technologies Corporation  
Lincolnshire, IL USA

Zebra and the stylized Zebra head are trademarks of ZIH Corp., registered in many jurisdictions worldwide. All other trademarks are the property of their respective owners.

©2016 Symbol Technologies LLC, a subsidiary of Zebra Technologies Corporation. All rights reserved.

